

## 二氧化碳激光光纤传输系统

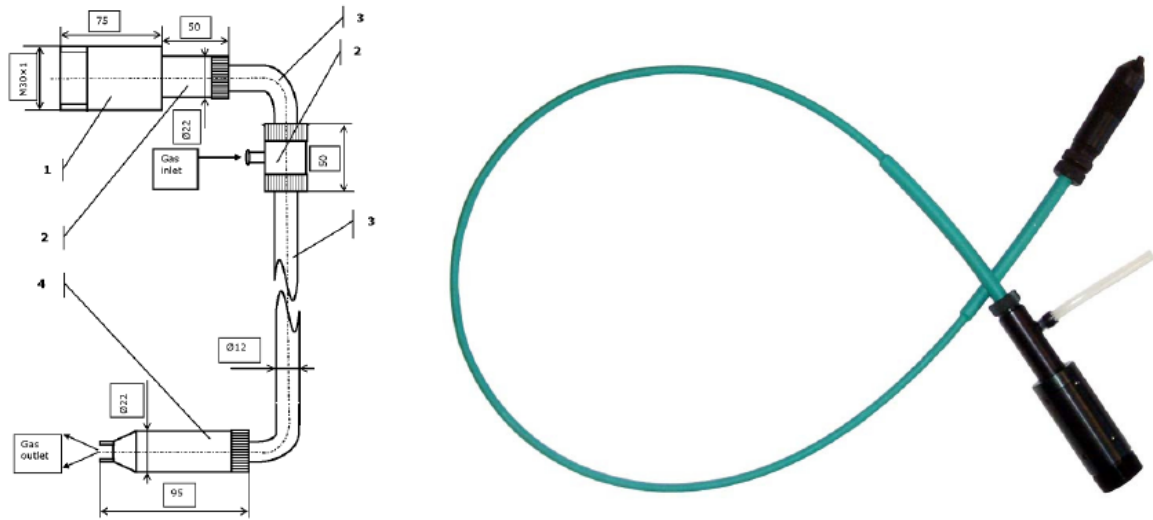

应用	主要用于工业和医疗激光传输，直接将激光束通过光纤传输到病人需要激光照射或开刀的部位，如口腔、泌尿系统、直肠等。	
系统主要零部件	1) 激光器到光纤的激光耦合器	
	2) 气密封单元	
	3) 多晶红外光纤	
	4) 聚焦手柄	
主要特性	1.5米光纤传输整体效率	>70%
	最大输入激光功率	连续50W
	光纤最小弯曲半径	10 cm
聚焦手柄参数	焦距手柄直径	22 mm
	焦距手柄长度	100 mm
	焦距光直径	0.65-0.9 mm
	工作距	20 mm
多晶红外光纤	使用多晶红外光纤，有外保护，可通冷却气体，钛SMA接头	
激光器到光纤的激光耦合器	输入激光束最大直径	8 mm
	耦合器直径	30 mm
	耦合器长度（含气密封单元）	140 mm
	接头尺寸	M30×1 mm
气密封单元	气嘴直径	6 mm
	承受气压	0.1-0.15大气压

地址：中国 广州 萝岗区科学城彩频路 11 号广东软件科学园 F 栋 2 楼

电话：+86 (020) 28395114/5167

传真：+86 (020) 28395073

 网址：[www.antelaser.com](http://www.antelaser.com) (中文)

[www.antelaser.cn](http://www.antelaser.cn) (English)

## 硫系红外光纤 (CIR 光纤)

硫系红外光纤是在1.5-6 $\mu$ m光谱段最好的传输光纤，正好添补了玻璃光纤(0.2-2.4 $\mu$ m)和多晶光纤PIR(4-18 $\mu$ m)的间隙，常用纤芯/包覆结构，光学传输损耗小，弯曲性能好，特别适合Er:YAG激光束传输。

### Features

- high transmittance from 1.5 $\mu$ m up to 6 $\mu$ m
- suitable for Er:YAG - laser power delivery
- optical losses 0.2 dB/m at 2-4 $\mu$ m
- double polymer coating for high flexibility
- durable cables with SMA-connectors

### Applications

- Flexible delivery for Er:YAG - laser
- flexible IR-imaging systems
- remote non-contact pyrometry in the 200-600K range
- fiber probes for remote process IR - spectroscopy

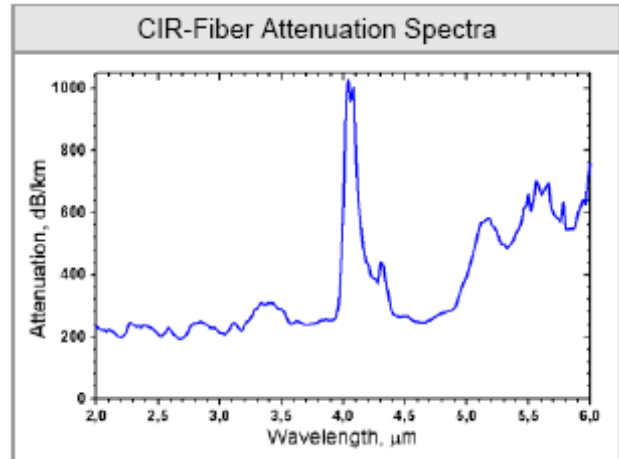

### Fiber specification

Transmission Range	1.5 - 6 $\mu$ m
Core/Clad Structure	As <sub>2</sub> S <sub>3</sub> /As-S
Core/Clad Diameter	200-500/300-600 $\mu$ m
Core Refractive Index	2.4
Effective NA	0.28
Protective Coating	Double Polymer Jacket
Ambient Temperature Range	270 - 370 K

### CIR Infrared Optical Fiber Standard Cables

Chalcogenide Infra Red (CIR) (1.5 - 6 $\mu$ m) fiber is drawn in core/clad structure with double polymer coating and characterized by a low optical losses and high flexibility. Delivery is from stock or within few weeks ARO. All standard cables include PEEK-polymer protective jacket and SMA termination.

## Polycrystalline Infra Red Fibers (PIR – Fibers)

The development of specialty fibers for the Mid-Infrared region has resulted in a unique product - Core / Clad Polycrystalline Infra-Red (PIR-) fibers. The PIR-fibers are non-toxic, very flexible, transparent across a broad spectral region 4 -18 $\mu$ m and capable of operating over the wide temperature range of 4K up to 420K. They are manufactured in a core/clad structure of superior quality from pure AgCl: AgBr solid solution crystals using an innovative vacuum extrusion method. They possess by no aging effect compared to an alternative bare core fiber.

The range of PIR-fiber cables are available with a durable PEEK polymer jacket and terminations using either an SMA - type connector with a Ti or polymer ferrule or special one, manufactured on customer request. A wide variety of different optical coupling units can also be designed & fabricated for specialized customer requirements.

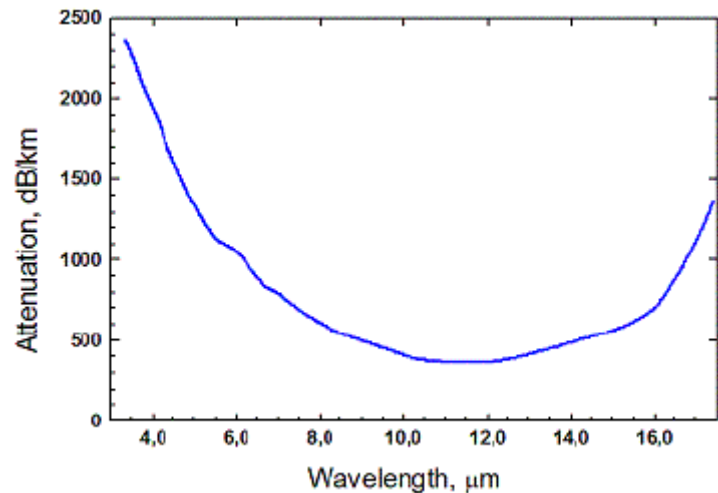

### Fiber Features:

- high transmittance from 4 $\mu$ m up to 18 $\mu$ m
- high flexibility and no toxicity
- suitable for CO<sub>2</sub> - laser power delivery up to 50W
- low Attenuation at 10.6 $\mu$ m (0.1-0.5 dB/m)
- fiber diameters from 0.3 to 1.0mm
- fiber lengths up to 20m (for 0.5mm diameter)
- no aging effect

### Standard Fiber Specification:

Standard Fiber Core/Clad Diameters Other fiber diameters in 0.3-1.5mm range are also available (request on special fabrication)	240/300, 400/500, 630/700, 900/1000 $\mu$ m
Transmission range	4-18 $\mu$ m
Attenuation at 10.6 $\mu$ m	0.1-0.5 dB/m
Refractive index	2.15
Standard Effective NA	0.25
Laser Damage Threshold for CW CO <sub>2</sub> -laser	>12 kW/cm <sup>2</sup>
Melting point	415°C
Tensile strength	>100 MPa
Minimum Bending Radius (fixed)	10x[Fiber Diameter]
Minimum Elastic Bending Radius	100x[Fiber Diameter]

地址：中国 广州 萝岗区科学城彩频路 11 号广东软件科学园 F 栋 2 楼

电话：+86 (020) 28395114/5167

网址：[www.antelaser.com](http://www.antelaser.com) (中文)

传真：+86 (020) 28395073

[www.antelaser.cn](http://www.antelaser.cn) (English)

PIR-fibers are protected by a loose PEEK-jacket (PolyEtherEtherKetone) to provide stiff, flexible and hermetic protection against mechanical, photoinduced and chemical damage over a wide temperature range up to 250°C.

#### **Standard Cable termination with a special Ti-ferrule SMA-connector:**

- for low power (spectroscopy & radiometry) applications;
- for high laser power delivery - free standing fiber end ;
- standard cable length - 1m & 2m.

#### **PIR-fiber end-surface treatment:**

- Cutting low cost, high performance - standard;
- Polishing for special application, including AR-coating - on request;
- SMART for reduced reflection of high CO<sub>2</sub>-laser intensity - on request.

#### **Options**

- accessory kits for remote spectroscopy with FTIR, QCL and TDL-spectrometers;
- pig-tailing of IR-detectors: TE- & LN-cooled MCT, PbSe, thermopiles, etc.

#### **Diverse Methods of AR-coating and SMART-treatment**

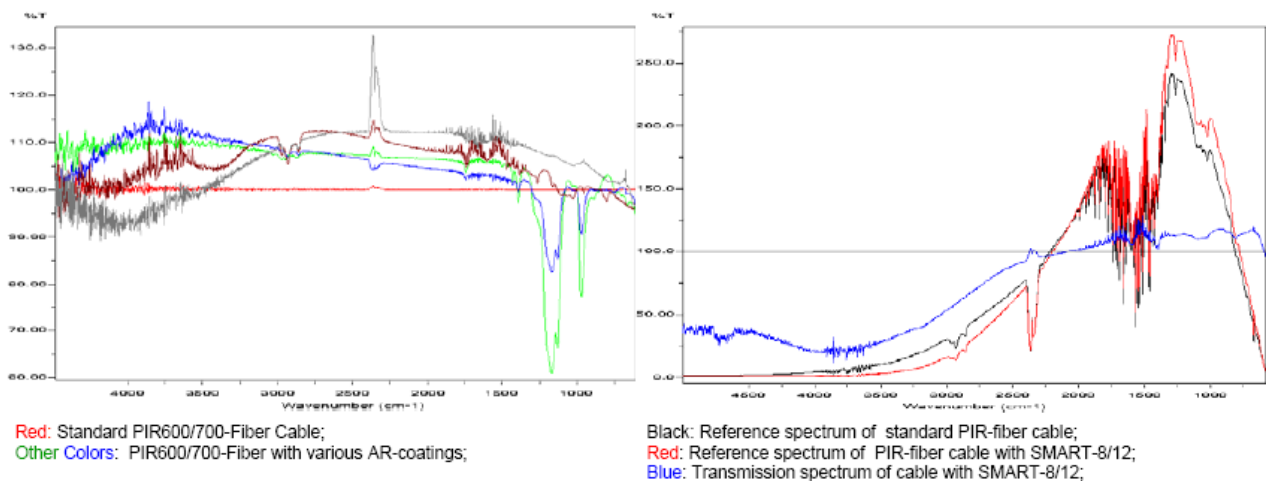

#### **Comparison of Standard and Spectral PIR-fibers**

地址：中国 广州 萝岗区科学城彩频路 11 号广东软件科学园 F 栋 2 楼

电话：+86 (020) 28395114/5167

网址：[www.antelaser.com](http://www.antelaser.com) (中文)

传真：+86 (020) 28395073

[www.antelaser.cn](http://www.antelaser.cn) (English)

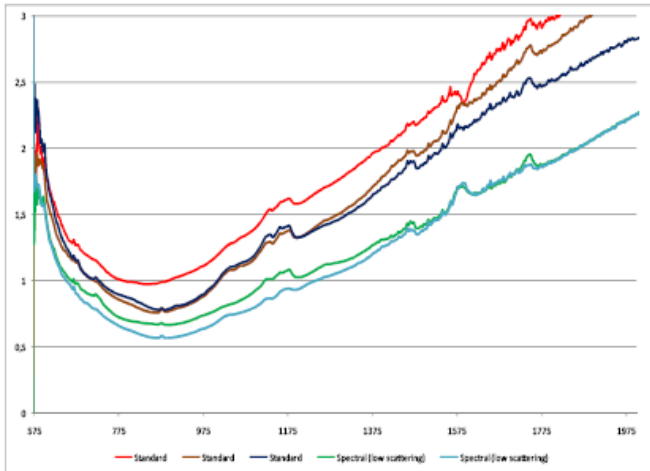

### Applications

- Flexible delivery system for CO and CO<sub>2</sub> laser;
- Flexible IR-imaging systems;
- Remote non-contact pyrometry in the 100-600K range;
- Fiber probes for remote in-line, in-vivo and process IR - spectroscopy.

地址：中国 广州 萝岗区科学城彩频路 11 号广东软件科学园 F 栋 2 楼

电话：+86 (020) 28395114/5167

网址：[www.antelaser.com](http://www.antelaser.com) (中文)

传真：+86 (020) 28395073

[www.antelaser.cn](http://www.antelaser.cn) (English)

## Comparison of CIR- and PIR-Fibers

Typical transmission spectra of 1.5m long PIR-900/1000 fiber (red) versus CIR-750/850 fiber (blue) (includes reflection & coupling losses at fiber ends without AR coating and some absorption bands of atmospheric moisture, etc.)

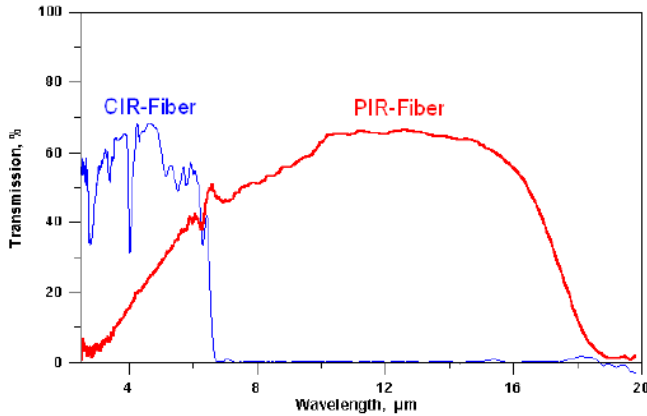

### Typical specification of CIR- and PIR-fibers

No.	Parameter	CIR-Fiber	PIR-Fiber
1.	Transmission range	1.5 to 6μm or 1600- 6500cm <sup>-1</sup>	3 to 18μm or 550 - 3300cm <sup>-1</sup>
2.	Core/Clad structure materials	Chalcogenide As-S glasses	AgCl:AgBr solid solution crystals
3.	Specific Features	Toxic & Fragile, Non-hygroscopic	Non-toxic, Non-hygroscopic, very flexible, slightly UV-sensitive
4.	Core/Clad diameter	200-500/300-600μm	400/500, 630/700, 700x700, 900/1000μm
5.	Core refractive index	2,4	2,2
6.	Effective NA	0,28	0,25
7.	Optical losses	Minimum of 0,2dB/m at wavelengths 2-4μm	Minimum of 0,2-0,3dB/m at wavelengths 10-12μm
8.	Operation temperature	From 270 to 370K	From 4 to 420K
9.	Max length of cable	Up to 50-100 meters	Up to 20-40 meters

### Comparison of PIR- and CIR-Fibers Transmission Spectra for 1,5m length

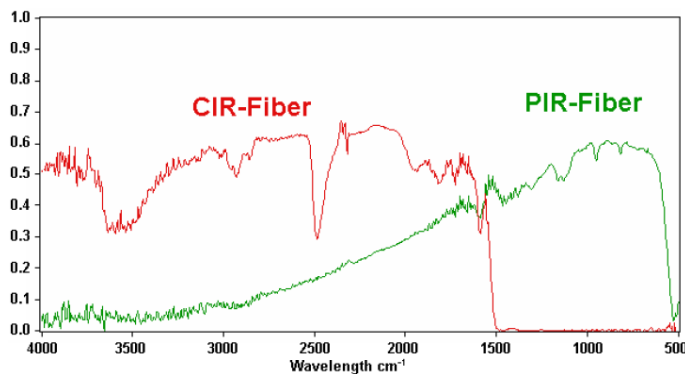

地址：中国 广州 萝岗区科学城彩频路 11 号广东软件科学园 F 栋 2 楼

电话：+86 (020) 28395114/5167

网址：[www.antelaser.com](http://www.antelaser.com) (中文)

传真：+86 (020) 28395073

[www.antelaser.cn](http://www.antelaser.cn) (English)

## High-power Fibers for Laser Power Delivery

High Power (HP-) Silica Cables are assembled with innovative HP-SMA-connectors made with inner Copper ferrules for free fiber end position and capable for durable delivery of laser power of high intensity in pulsed or cw mode in the range below 1kW (cw).

Super High Power (SHP-) Silica Cables could deliver up to several kW from Diode and Solid State lasers resulting from their assembly with a larger size SHP-connectors of special design with diameter spans 2.5, 4, 10 and 15mm - or with Mitsubishi connectors of D-80 and D-200 types. Bespoken SHP-connector design may include Copper ferrule protection by Sapphire rings to prevent Copper evaporation by intensive laser beam.

Fiber Core Diameter ( $\mu\text{m}$ )	100	200	400	600	800-1000	1000-2000
Max Power (kW)	>0.1	>0.6	>1	2-4	6-8	>8

HP- and SHP-cables can be protected by polymer coated metal armor or MKS-jacketing (Stainless Steel / Kevlar / Silicon) for durable protection of silica fibers inside – which diameter spans from 100 $\mu\text{m}$  to 2mm. In-house technology of precise assembly allows to assembled single HP & SHP-cables with a length from 50mm to 100m.

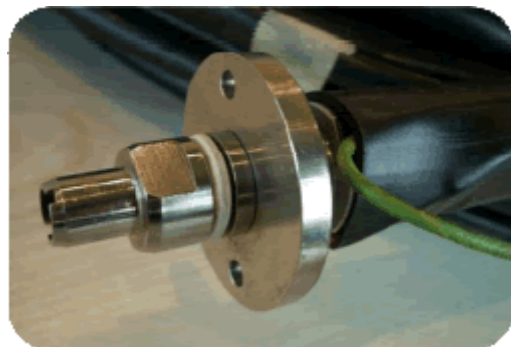

### Specifications:

All silica fiber NA = 0,22, default length 1m, protected in stainless steel(inside) and fabric silicone (outside) tubing (out diameter 6mm, grey), terminated with 2x SMA905 free end connectors, electrically disconnected

Part number	ST-SMA905-F100	ST-SMA905-F200	ST-SMA905-F400	ST-SMA905-F600
Fibre core diameter ( $\mu\text{m}$ )	100	200	400	600
Fibre cladding diameter ( $\mu\text{m}$ )	140	280	480	720
Max. laser power (W)	70	150	150	150
Short term bending radius (cm)	1.1	2.1	3.6	5.4
Long term bending radius (cm)	4.2	8.4	14.4	21.6

地址：中国 广州 萝岗区科学城彩频路 11 号广东软件科学园 F 栋 2 楼

电话：+86 (020) 28395114/5167

传真：+86 (020) 28395073

网址：[www.antelaser.com](http://www.antelaser.com) (中文)

[www.antelaser.cn](http://www.antelaser.cn) (English)

Fiber length: other lengths available upon request.

Order Information:

ST-SMA905-Fxxx-yyyy: xxx is core diameter in um and yyy is fiber length in mm.

1) HP- & SHP-cables based on UV- & NIR-Silica glass for flexible power delivery of Diode, Solid State, DPSS and Gas lasers – which durable exploitation is secured by low optical losses in fiber of special structure, by innovative design of HP- & SHP-connectors, by proper fiber protection with armored MKS-jackets and by inhouse test of all cables performance;

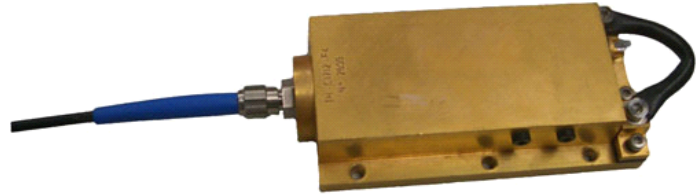

2) HP- & SHP-cables based on special Silica fiber coated by Aluminium, Copper or Copper alloys – where unique technology of metal freezing on lateral fiber surface doubles fiber bending strength, accelerates dissipation of laser induced heat from the fiber under delivery of high power and enables cables applications at high temperatures up to 600°C;

3) HP-Silica Fiber Summarizers for fiber collection of power from 3 to 7 Diode Laser Modules - provides above 100W of combined laser power at the input of HP-Refocuser of special design and then this refocused power is homogenized by HP-fiber Homogenizer. This 3 component HP-Silica Fiber System provides flexible solution for multiwavelength laser combination and for medical applications like hair epilation in cosmetology;

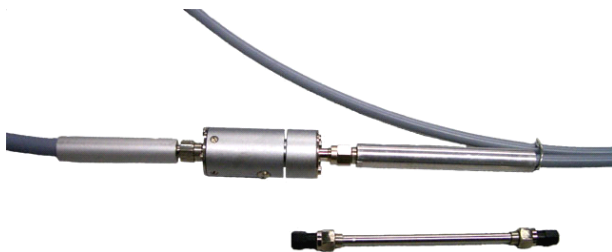
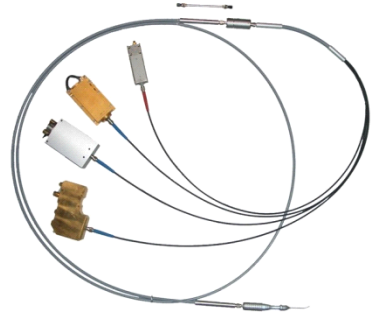

4) HP-Silica Fiber Dental Applicators (SFDA) – for disposable applications in advanced laser dentistry and ENT laser surgery. Variety of HP-Silica cables for medical lasers includes the design where fibers are assembled with electric wires in the same protective jacket – as it is required for remote control and variation

of laser parameters during laser surgery. Distal fiber ends may be terminated with a variety of hand-pieces of bespoke design.

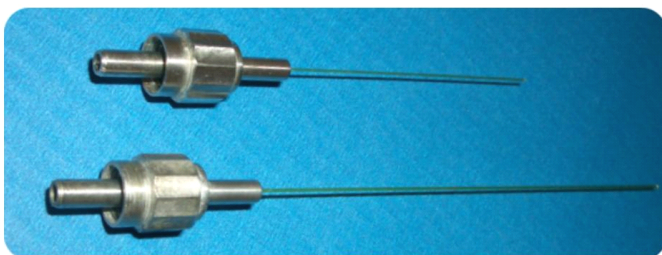

## Refocusing & Collimating Fiber/Lens Objectives

### Features

- Compatible with SMA-terminated fiber cables
- NA=0.35, Pupil diameter 14 mm
- Refocusing or collimating design

### Applications

- Focusing of collimated beam into fiber
- Collimation of output beam from fiber
- Fiber end imagnation to detector / emitter element

### Technical parameters

- Z-translation stage adjustable in  $\pm 5$  mm range
- Lens parameters
- ZnSe or Ge - on request
- $\varnothing 15$  mm;  $f = 20$  mm or  $10$  mm - on request
- AR - coating for  $3-5.5\mu\text{m}$  or  $8-12\mu\text{m}$  - on request



### Drawings

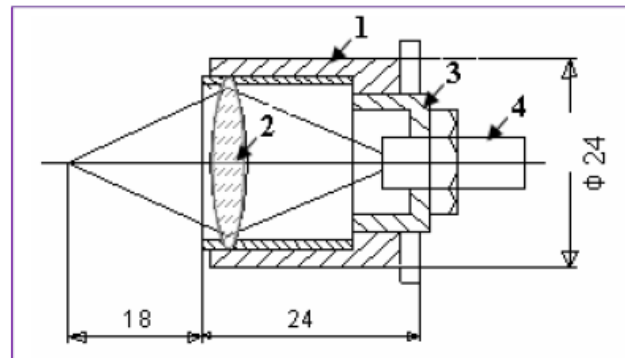
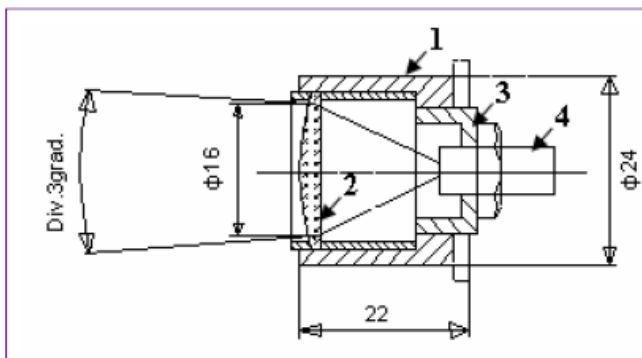

- 1-Case
- 2- Lens
- 3- Z-translation stage
- 4- SMA-Adaptor